



# CPP EVO Function Guide

Supports: CPP EVO

V1.1

Conspit R&D

All rights reserved@2024



## Table of Contents

Table of Contents .....	1
1. Mechanical Adjustment .....	2
2. Driver Software & Functions .....	5
2.1 Driver Software Downloads .....	5
2.2 Homepage .....	5
2.3 Pedals Settings .....	8
2.4 Vibration Settings .....	11
2.5 Launch Control Settings .....	13
2.6 Firmware Update .....	16
2.7 One-Click Game Configuration .....	17
3. Game Compatibility List .....	18
4. Troubleshooting Guide .....	19
5. Revision History .....	20
6. Disclaimer and Copyright Notice .....	20

# 1. Mechanical Adjustment

Decoupling adjustment of throttle travel and spring preload force:

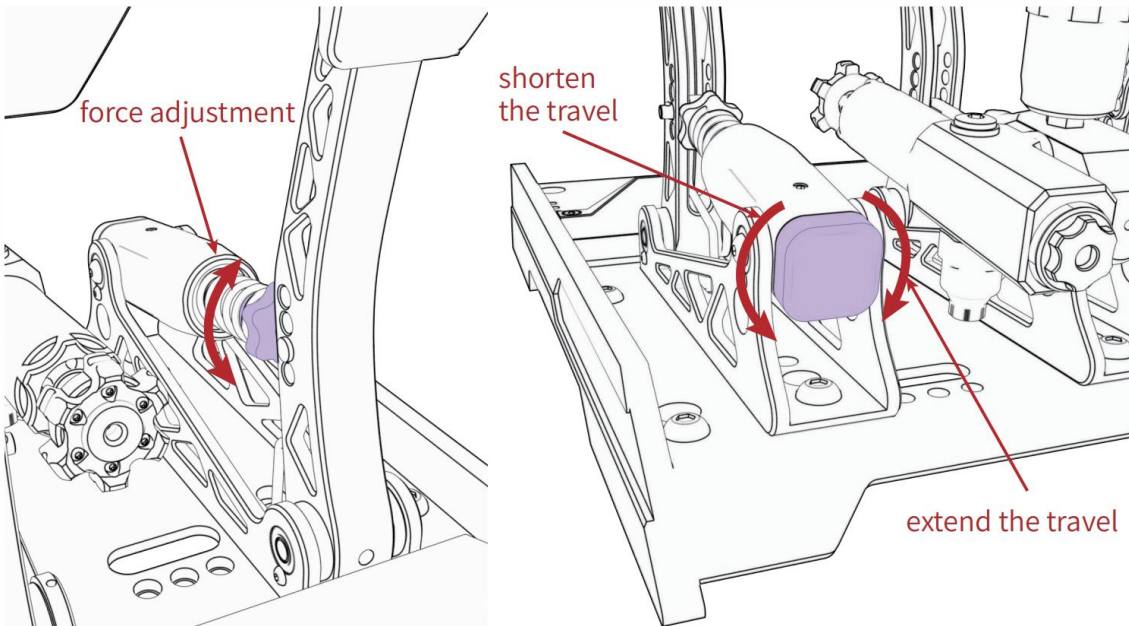

**Four-level quick adjustment of pedal strength:**

(This method can be used if it is difficult to re-insert the brake pedal locking pin after it is pulled out.)

Unscrew the front adjustment knob of the brake pedal.

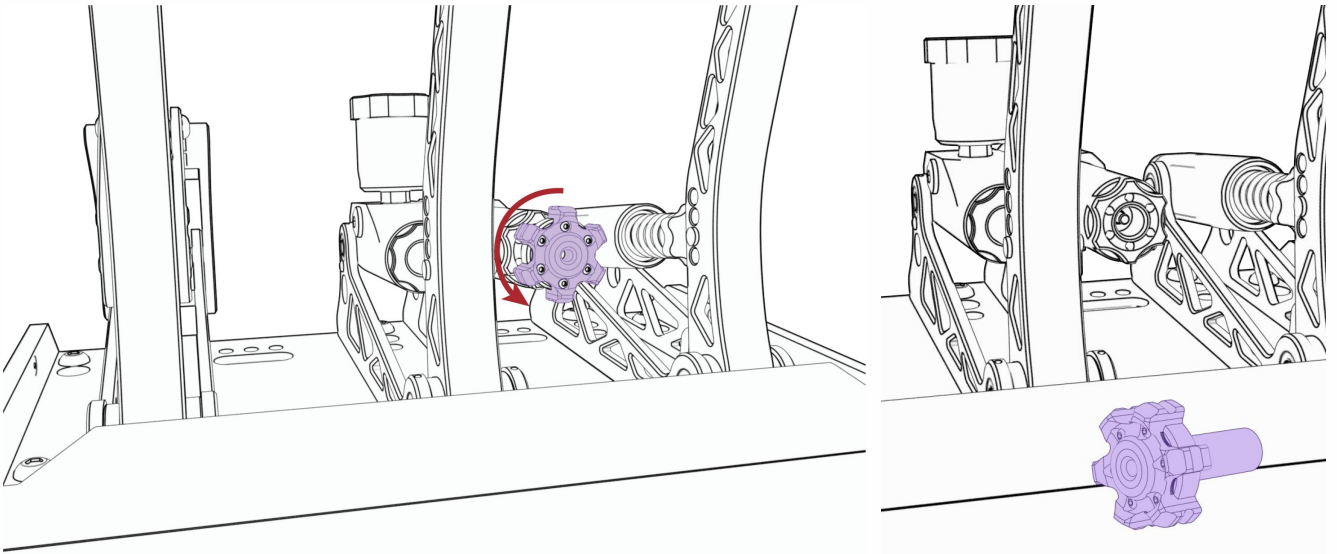

Loosen the rear adjustment knob of the brake pedal.

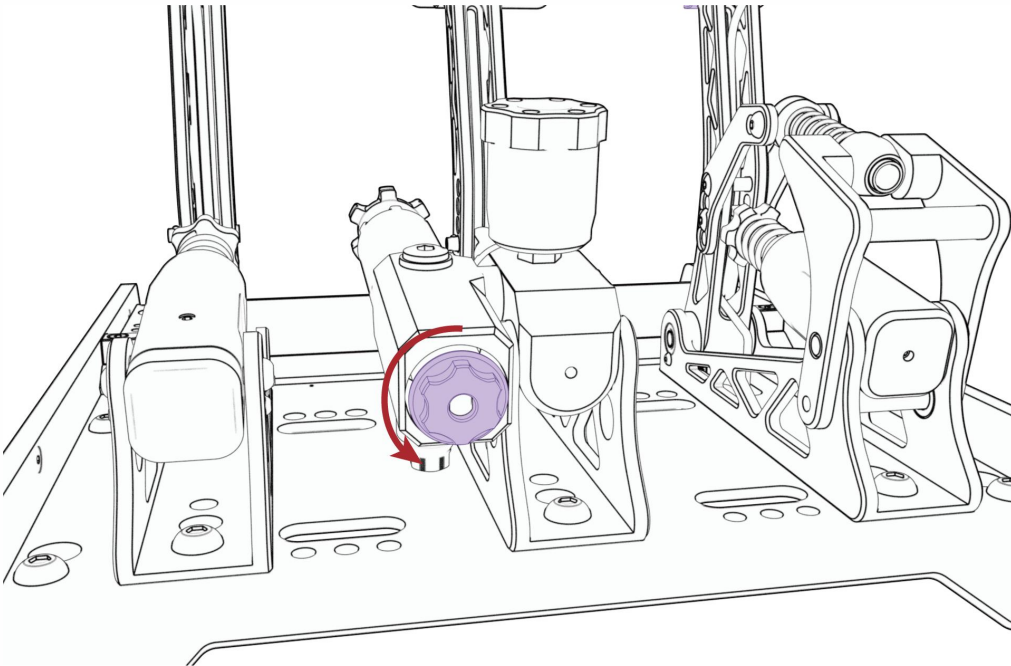

Push out the pin and adjust it in four levels. After adjustment, put back the previously removed knobs.

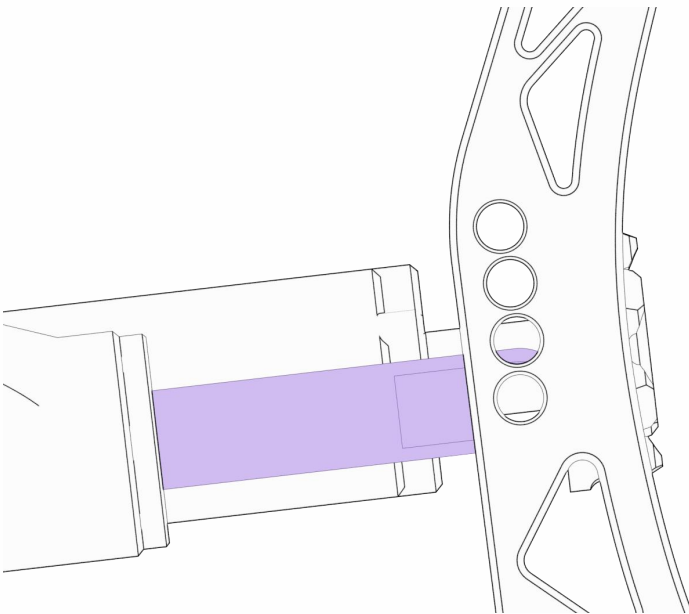
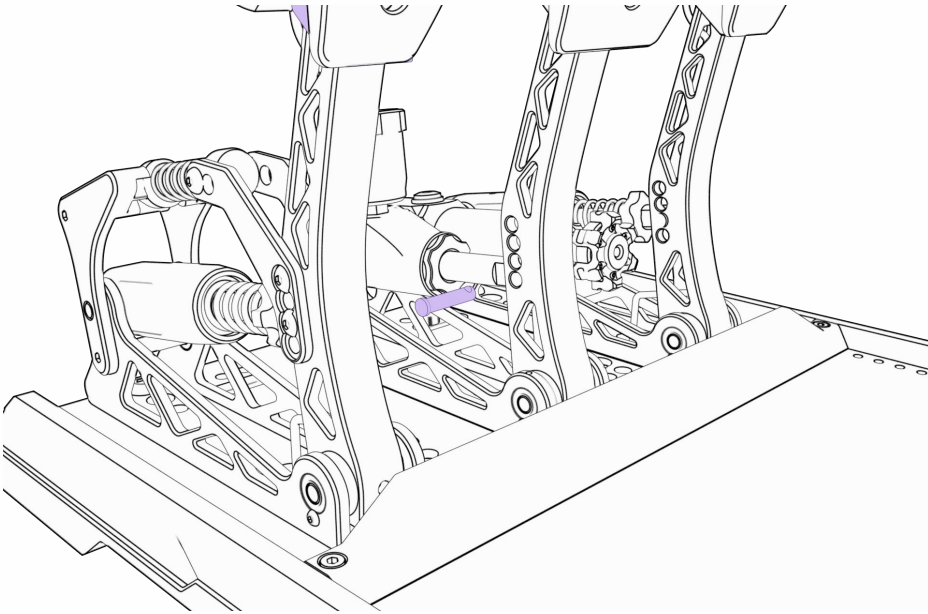

Note: This part of the clutch pedal is not adjustable.

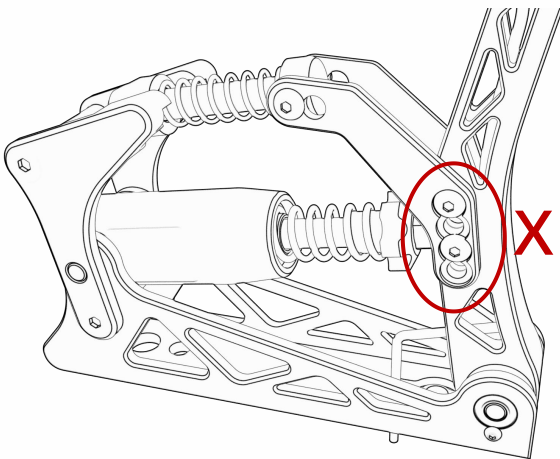



## 2. Driver Software & Functions

### 2.1 Driver Software Downloads

Visit [www.conspit.com](http://www.conspit.com), or scan the QR code below to download Conspit Link 2.0.



### 2.2 Homepage

Click to select CPP EVO on the homepage.

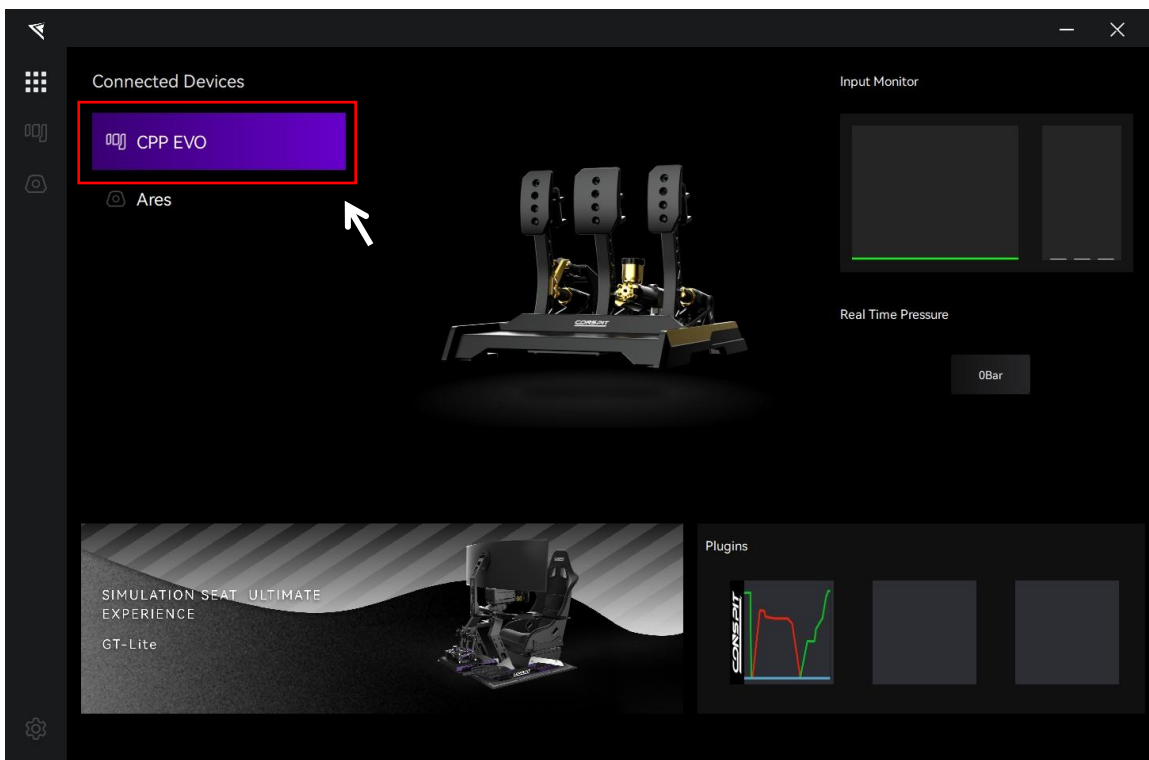



On the right side of the homepage, You can quickly check the real-time input and the current pressure of the device.

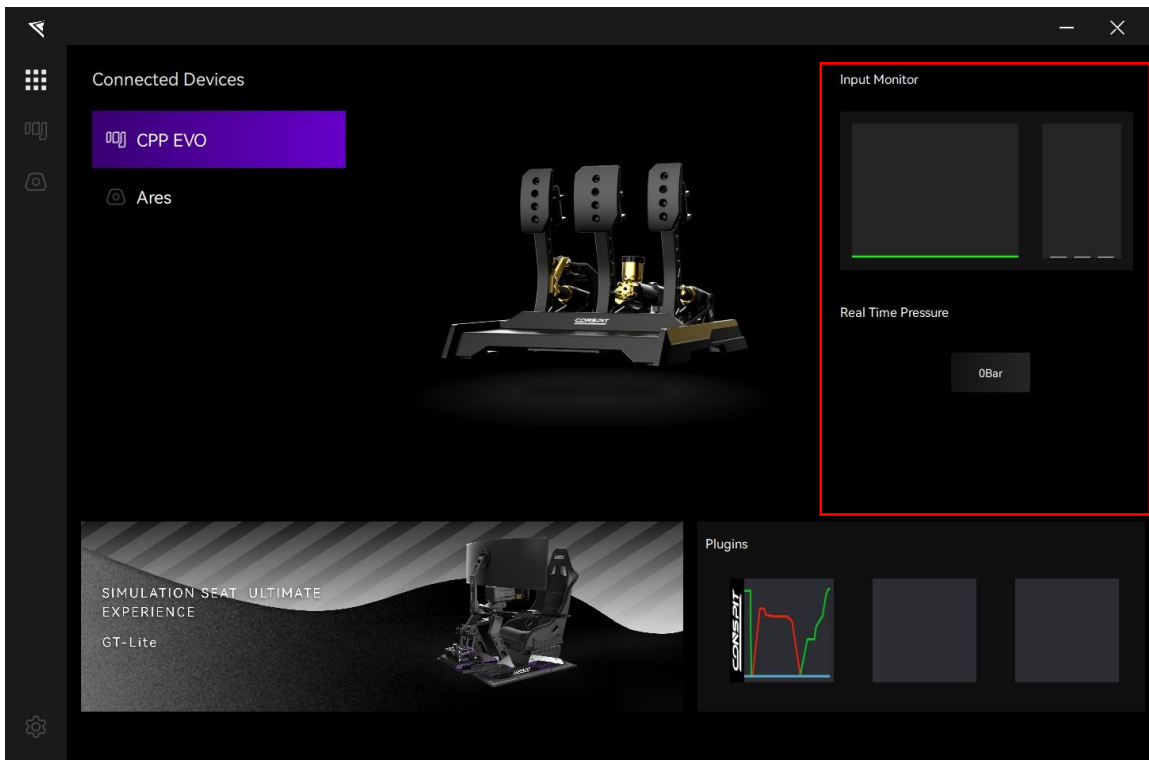

At the bottom of the homepage, you can activate the plugin to monitor the inputs of the pedal and steering wheel in real-time through a floating window.

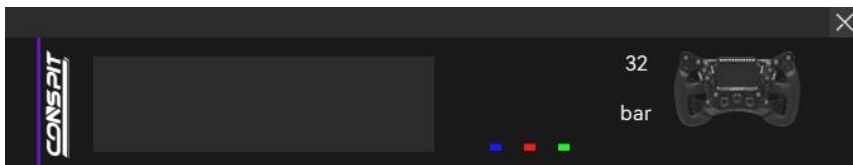
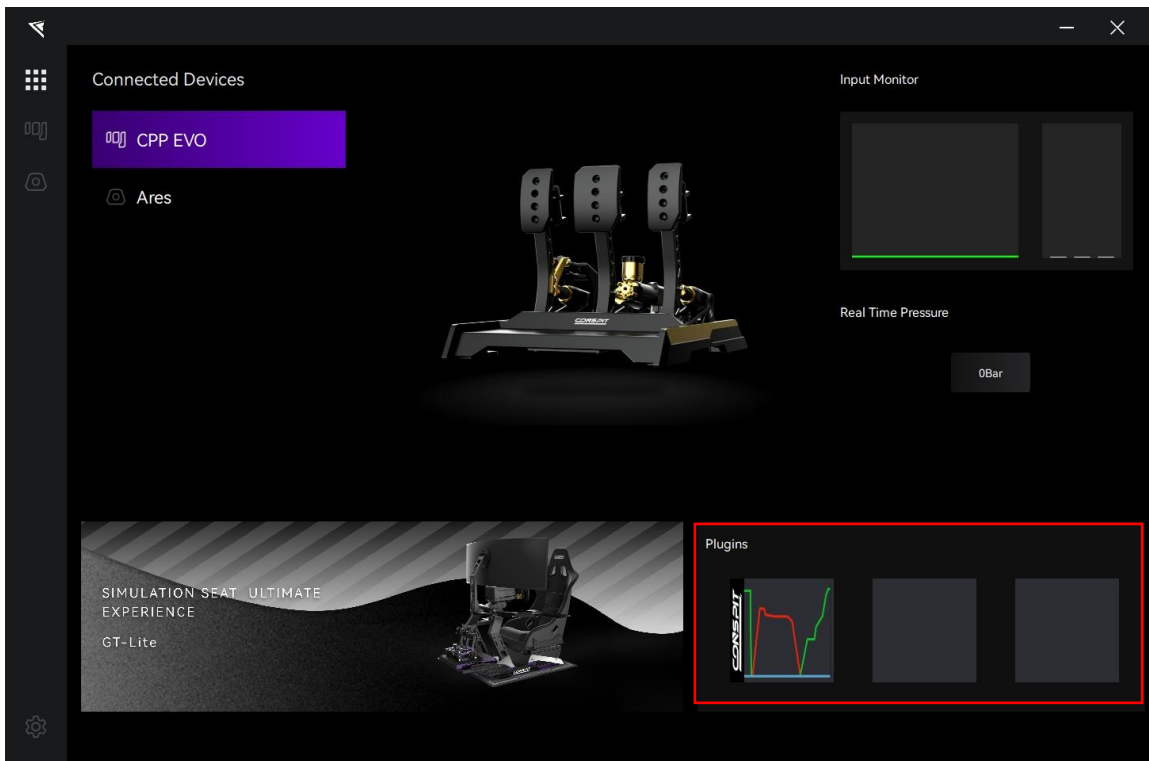



Double-click the device name in the “Connected Devices” list, or click the corresponding icon of the device to enter the detailed settings pages.

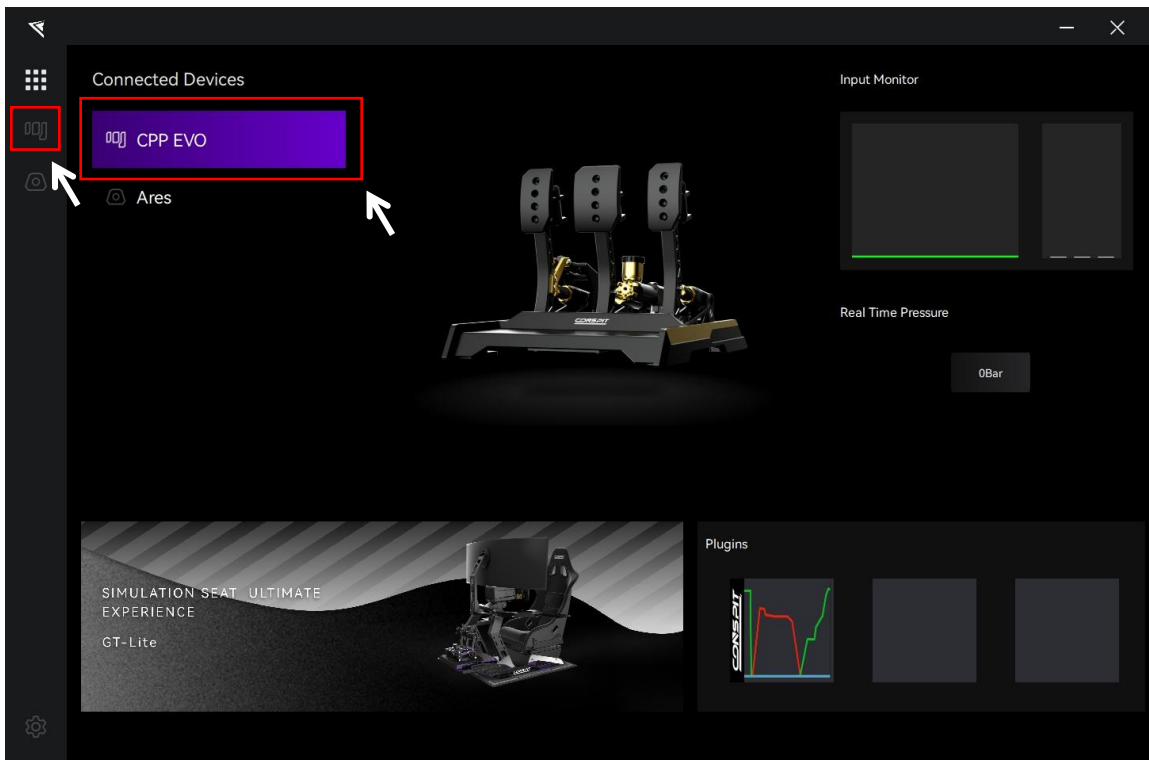





## 2.3 Pedals Settings

Click on "Pedals" in the menu bar to enter the pedals settings interface.

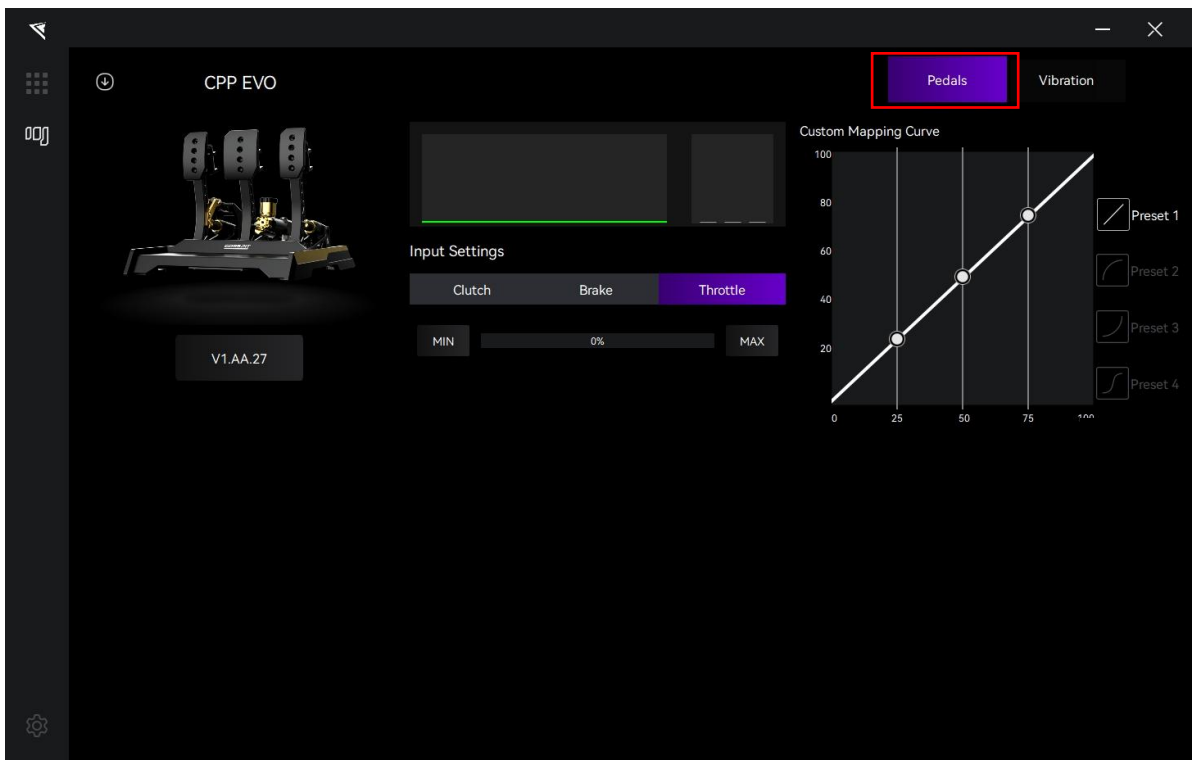

### Inputs:

In the middle of the page, you can monitor and check the real-time input of the device, and calibrate the input of the throttle, brake, and clutch pedals.

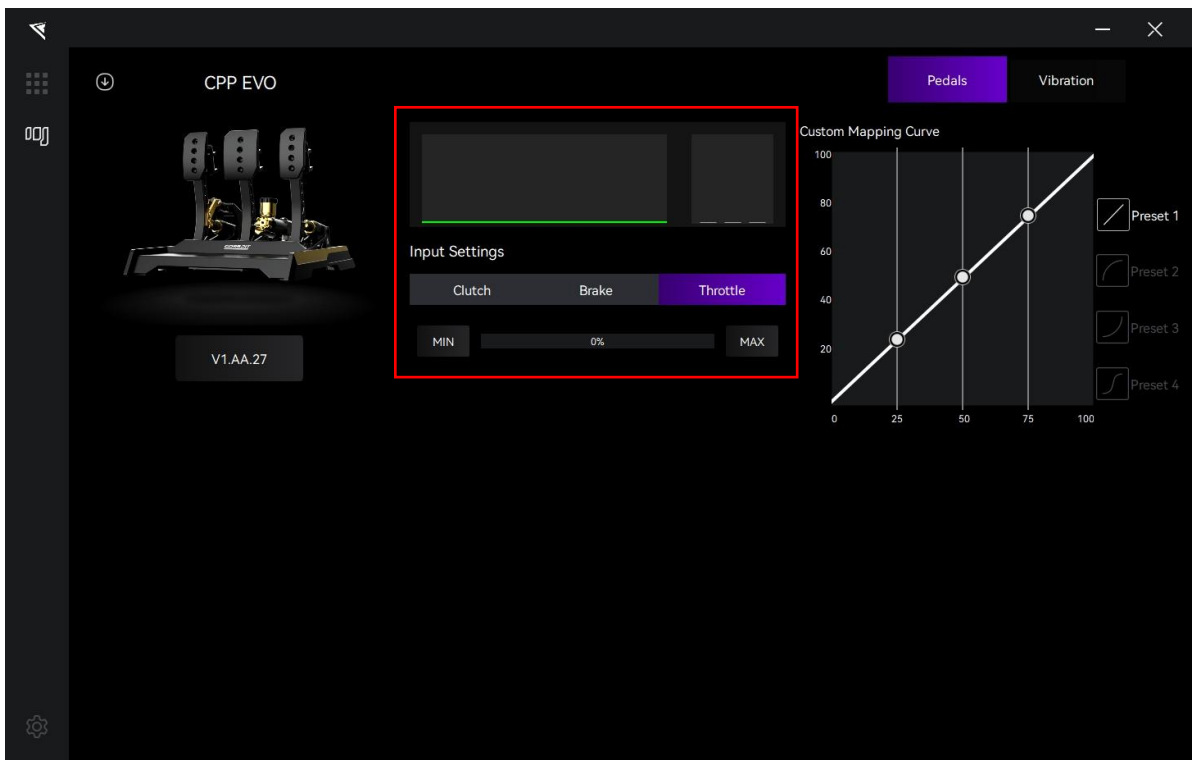



Select "Throttle" "Brake" or "Clutch".

Click "MIN" to calibrate the minimum value when the pedal is completely released.

Click "MAX" to calibrate the maximum value when the pedal is fully pressed.

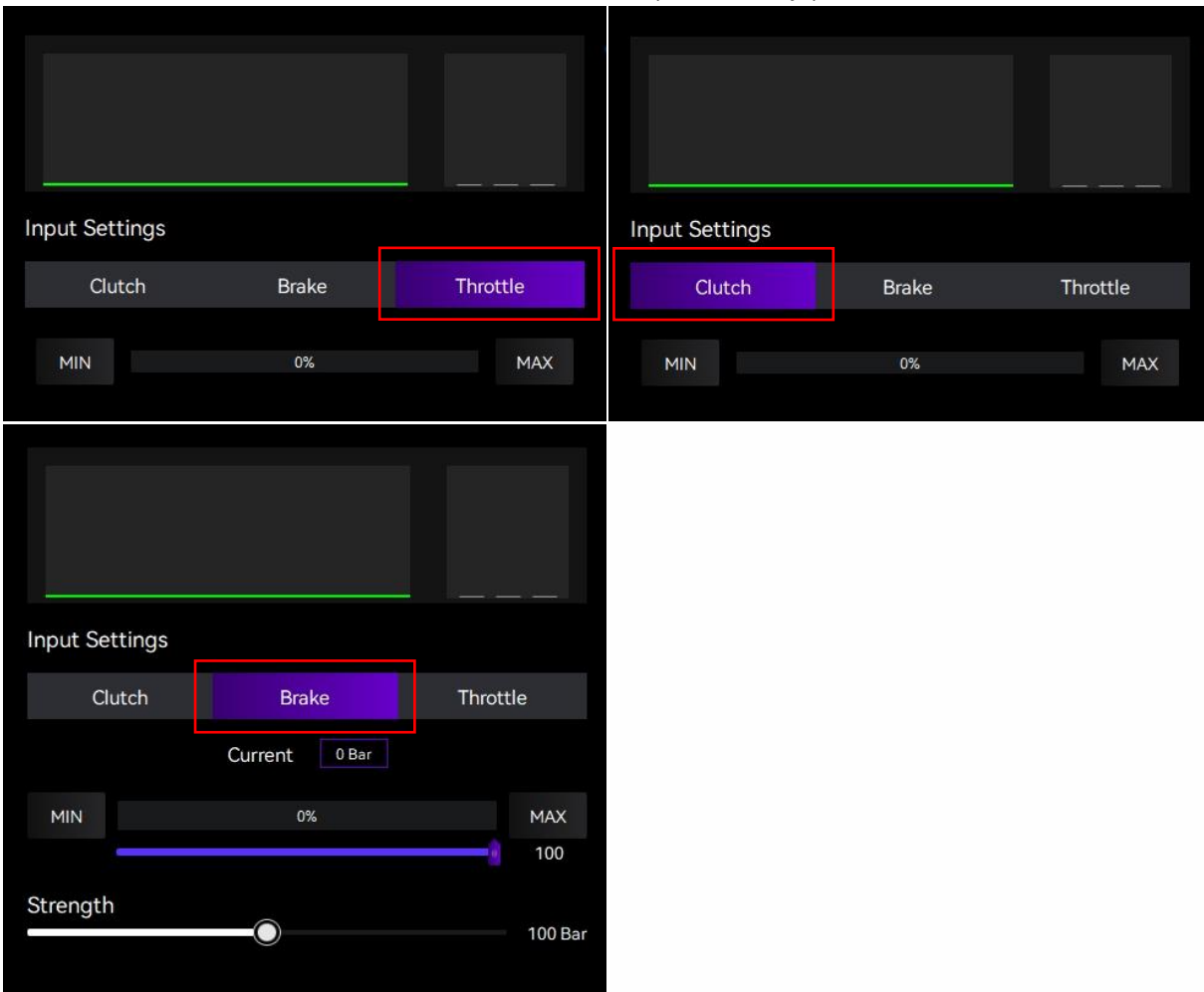

When "Brake" is selected, adjust the upper limit of brake travel input:

adjust the upper limit of brake force:

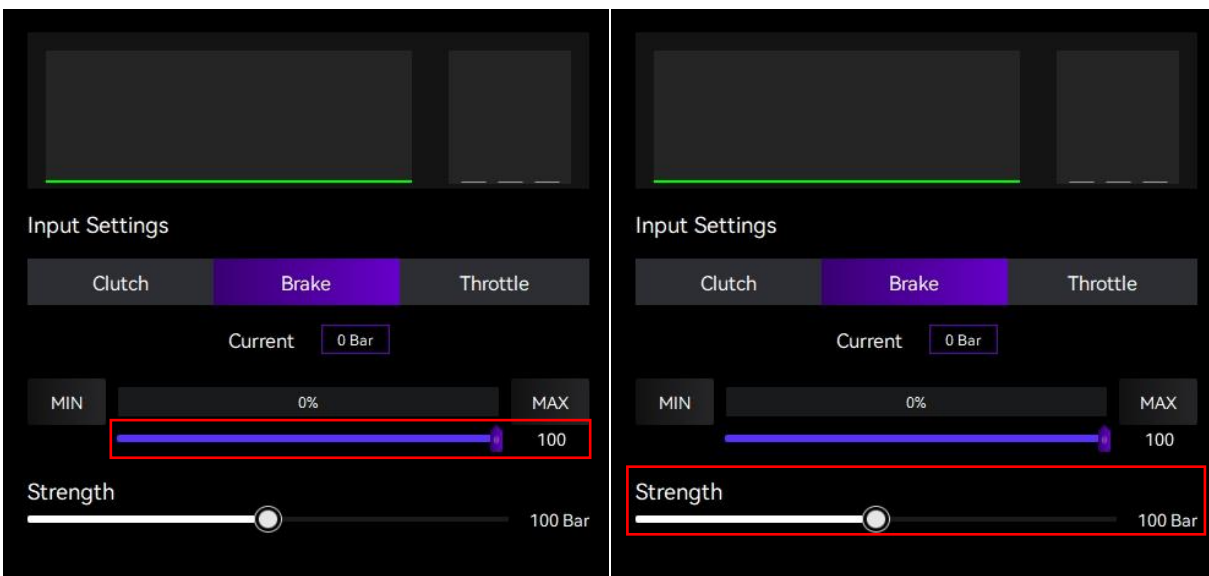

### Custom Mapping Curve:

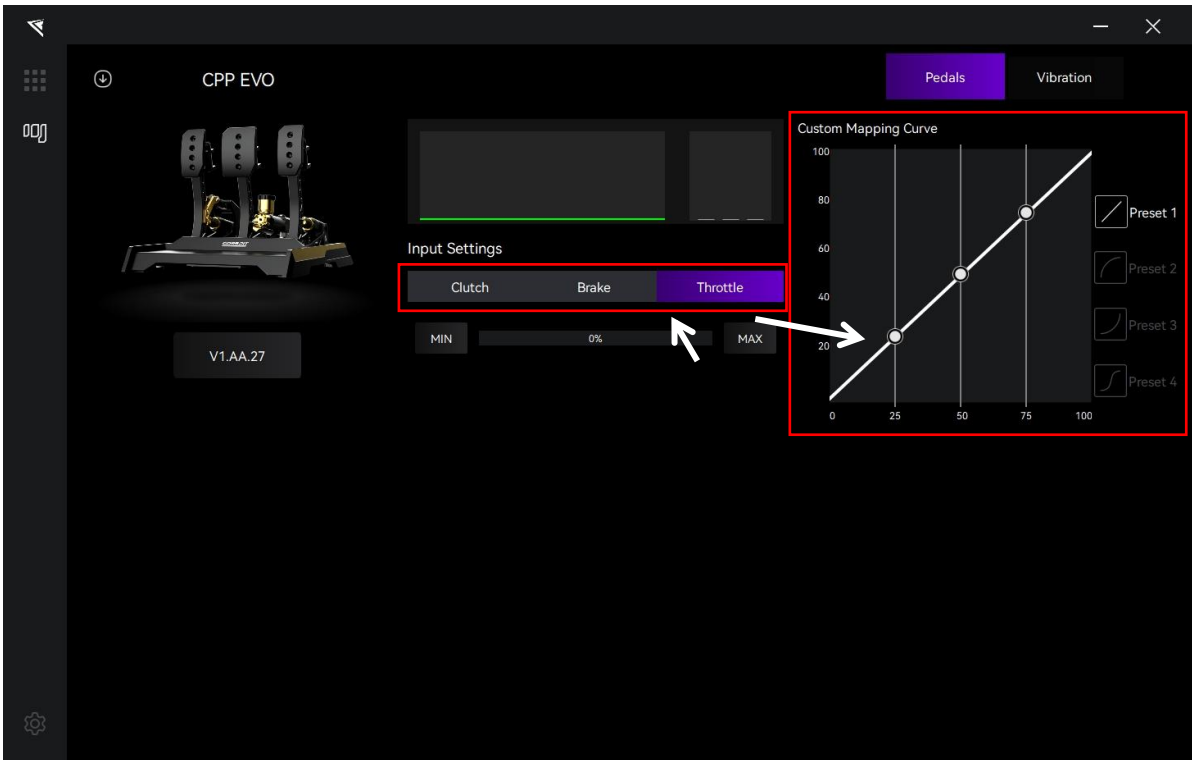

After selecting "Throttle", "Brake", or "Clutch" in the middle of the page, you can choose from the four default preset mapping curves for each of the three pedals on the right side of the page, or drag the control points to customize the mapping curve.



## 2.4 Vibration Settings

Click on "Vibration" in the menu bar to enter the vibration settings interface.

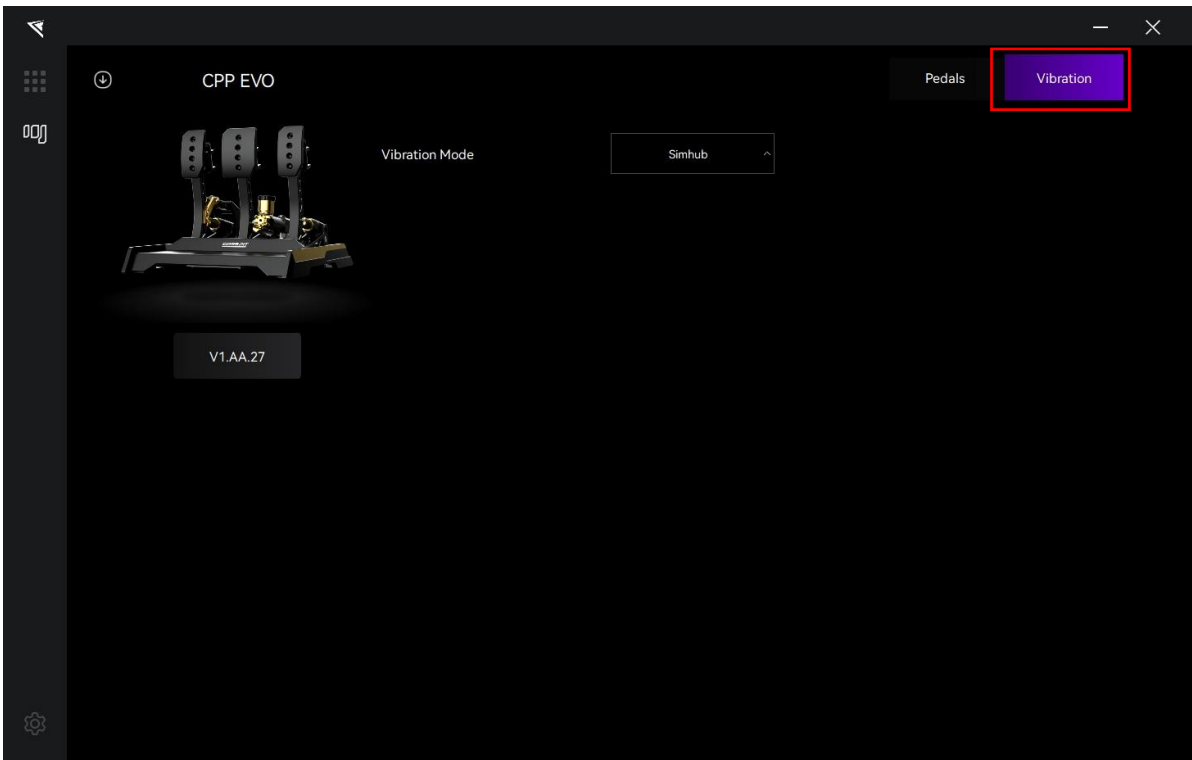

In the middle of the page, you can select the desired vibration mode from the drop-down box.

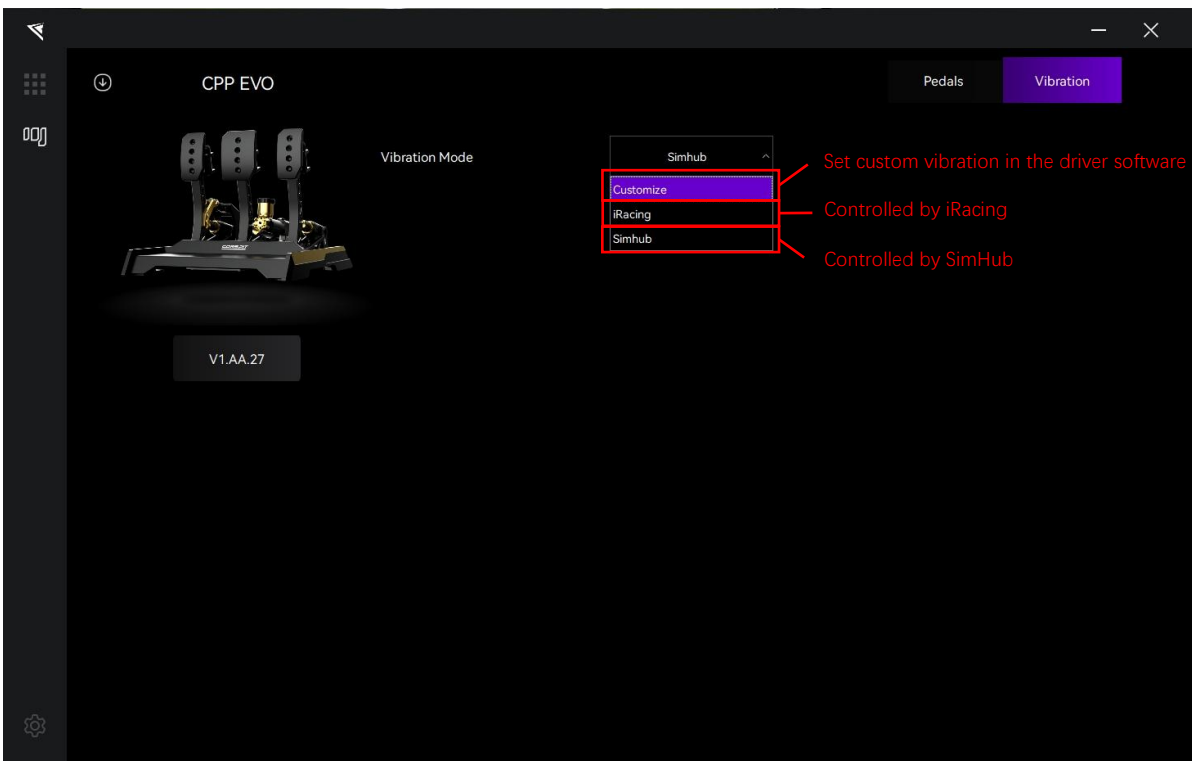



If the vibration mode is selected as "Custom", you can set the vibration mode and intensity for the throttle, brake, and clutch separately. Select "Throttle", "Brake", or "Clutch" to enter the vibration settings interface for the corresponding pedal. Click the "Test" button to test the vibration of each pedal individually.

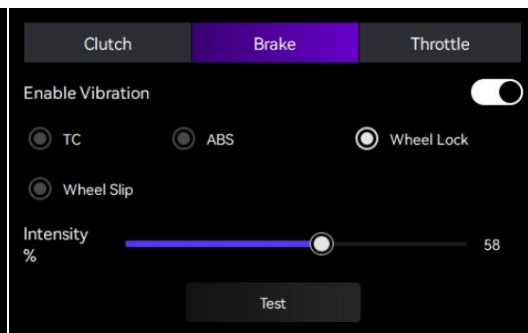
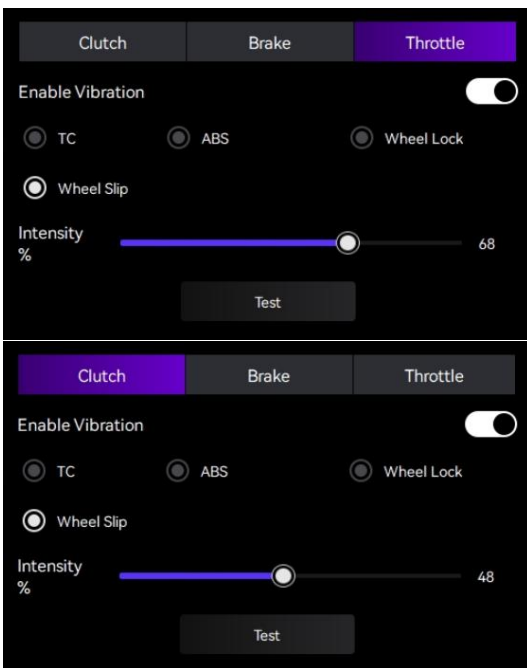
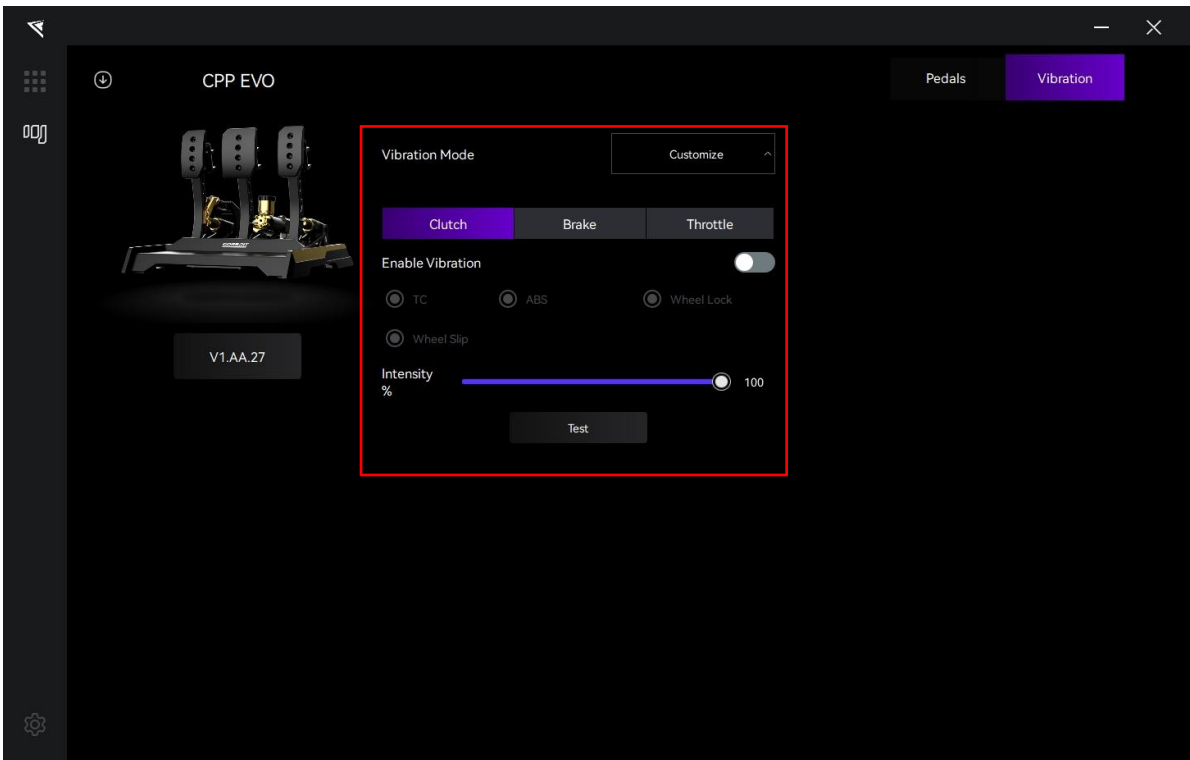



## 2.5 Launch Control Settings

This product has added a launch control function in the driver version CONSPIT LINK 2.0\_v1.1.1. Click on "Launch Control" in the menu bar to enter the vibration settings interface.

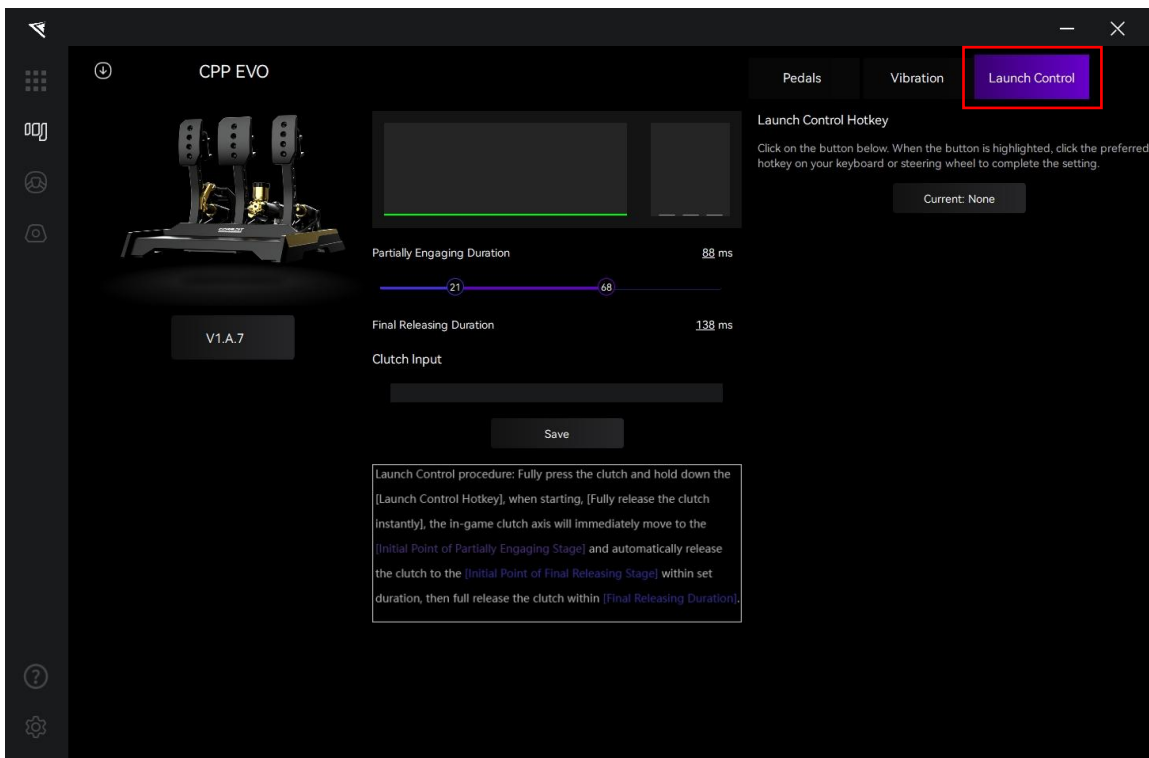

Launch Control Hotkey: Click on the button below. When the button is highlighted, click the preferred hotkey on your keyboard or steering wheel to complete the setting.

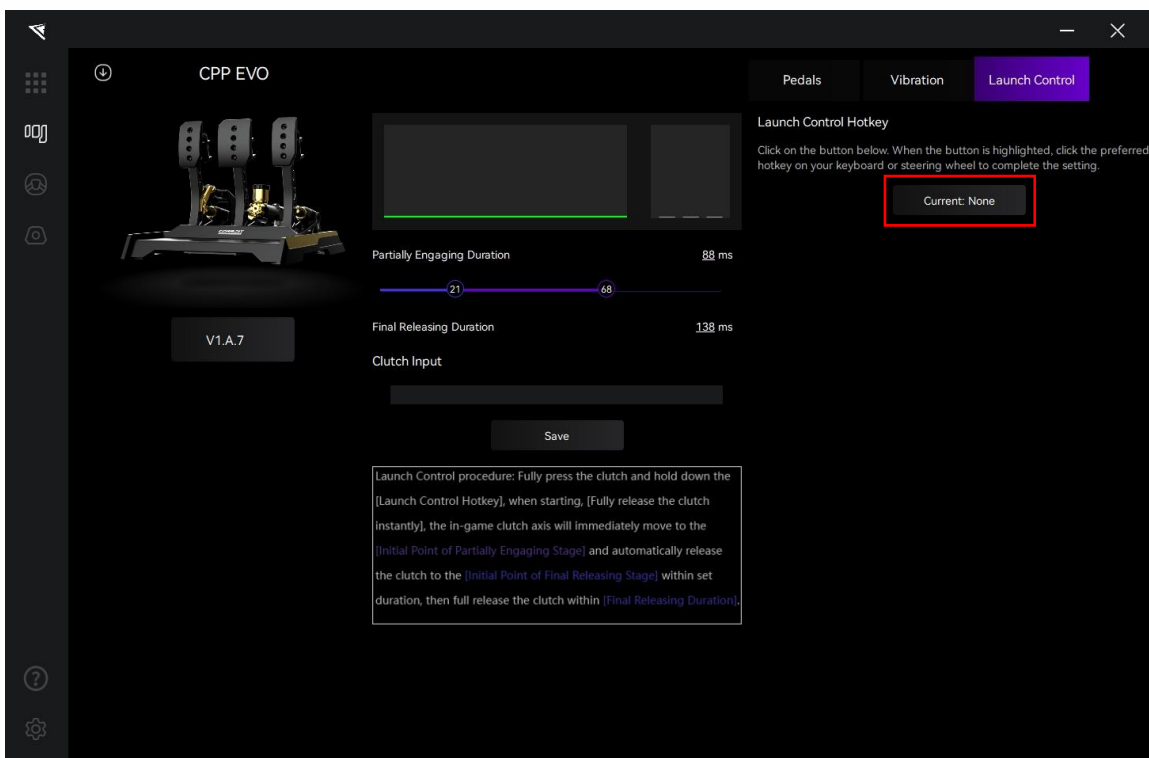

Set the **Partially Engaging Duration** and the **Final Releasing Duration**.

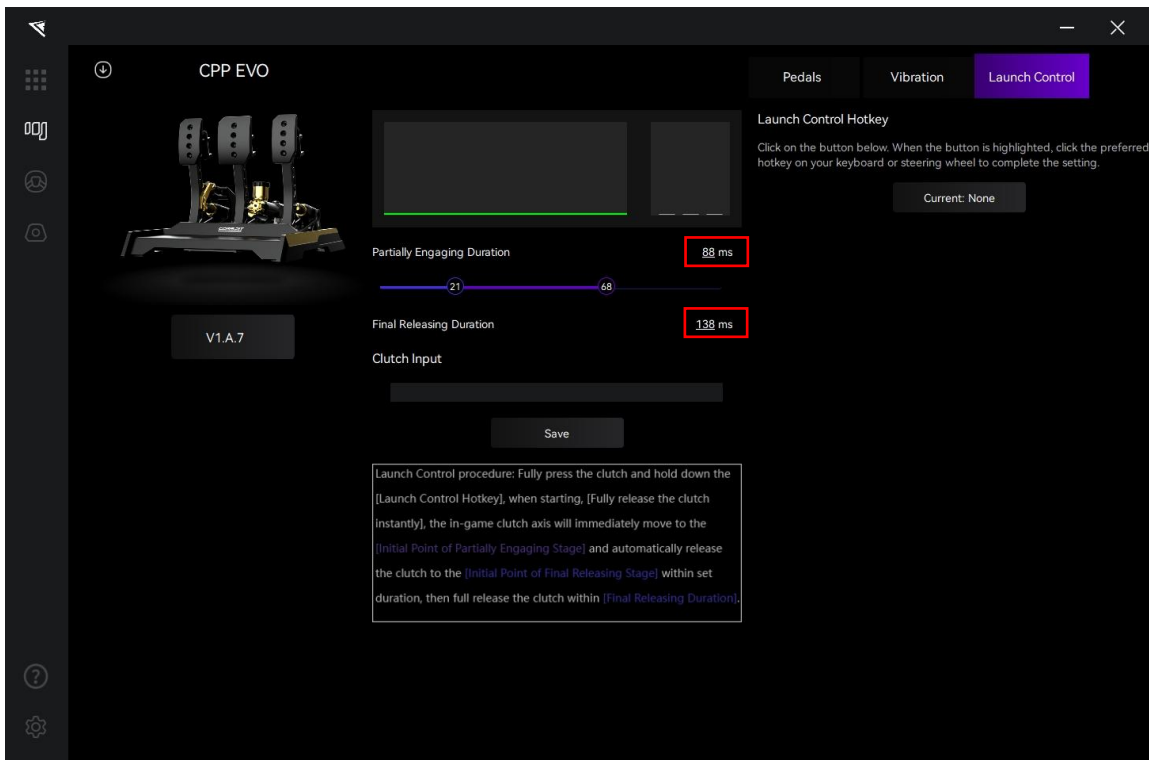

Use the slider to set the Initial Point of **Partially Engaging Stage** and the **Final Release Stage**.

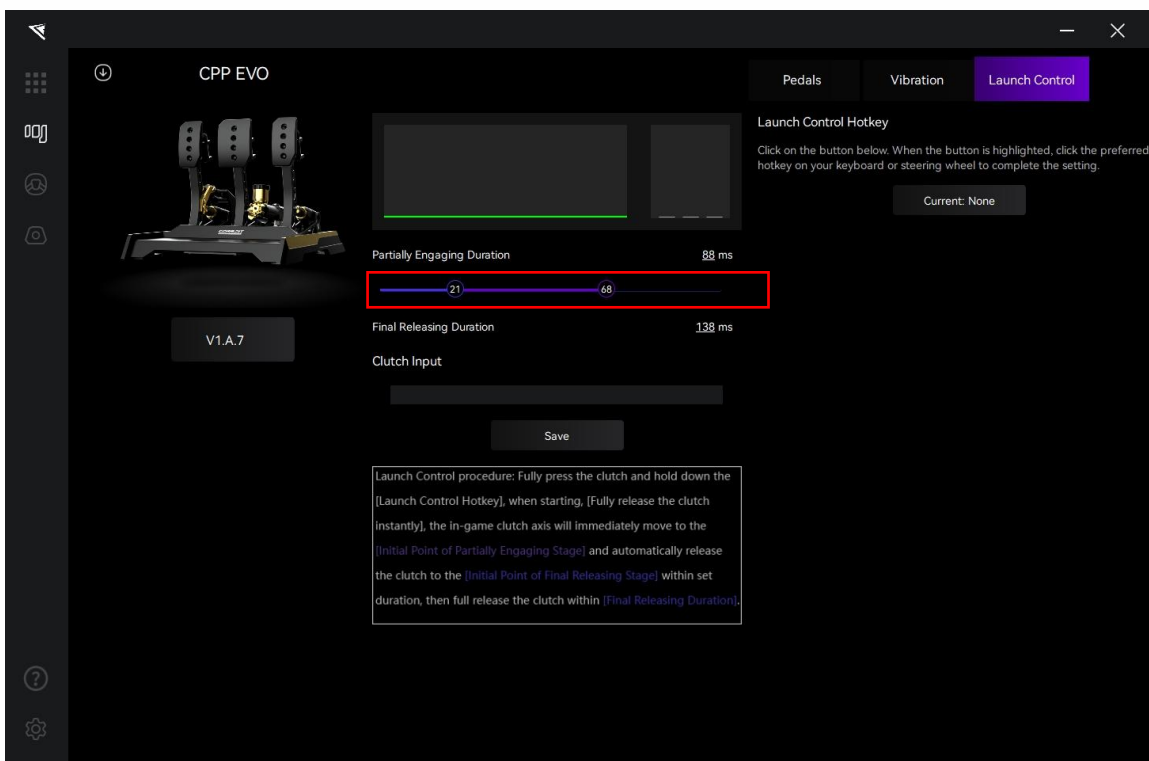



Click on "Save" after setting.

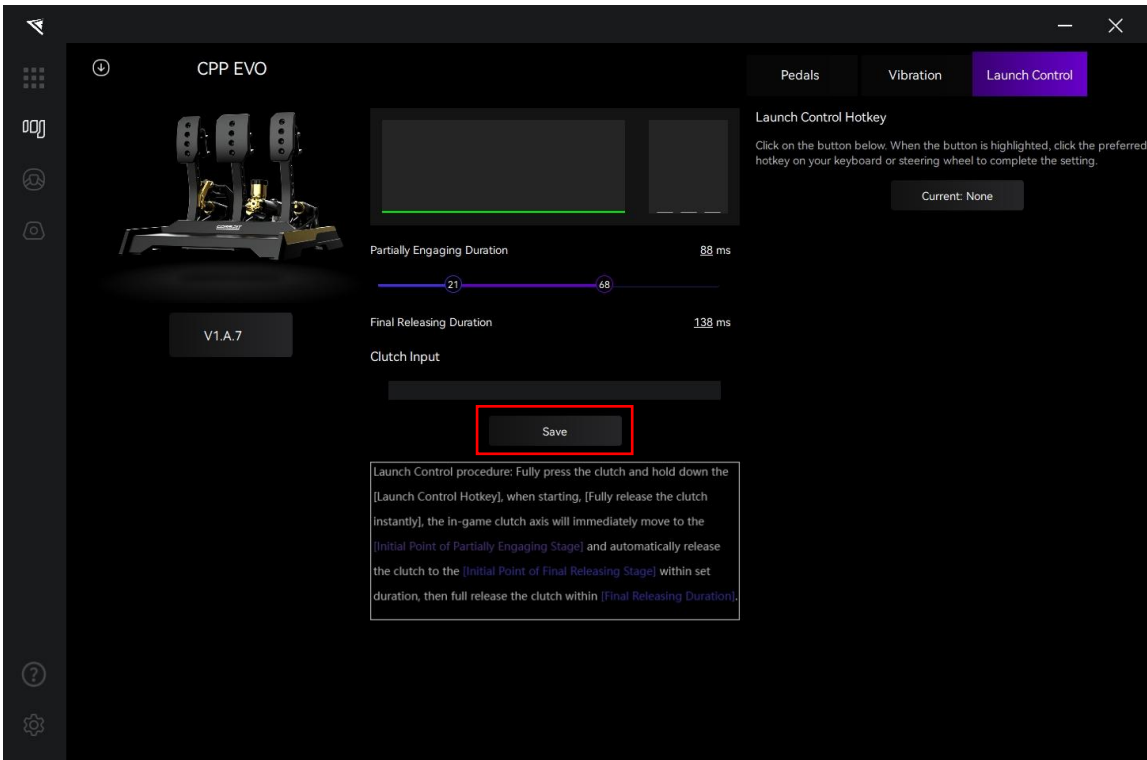

Launch Control procedure: Fully press the clutch and hold down the [Launch Control Hotkey], when starting, [Fully release the clutch instantly], the in-game clutch axis will immediately move to the [Initial Point of Partially Engaging Stage] and automatically release the clutch to the [Initial Point of Final Releasing Stage] within set duration, then full release the clutch within [Final Releasing Duration].





## 2.6 Firmware Update

Visit [www.conspit.com](http://www.conspit.com) to download the firmware for the corresponding product;

Enter the detailed settings pages and click the "↓" symbol in the top left corner to update.

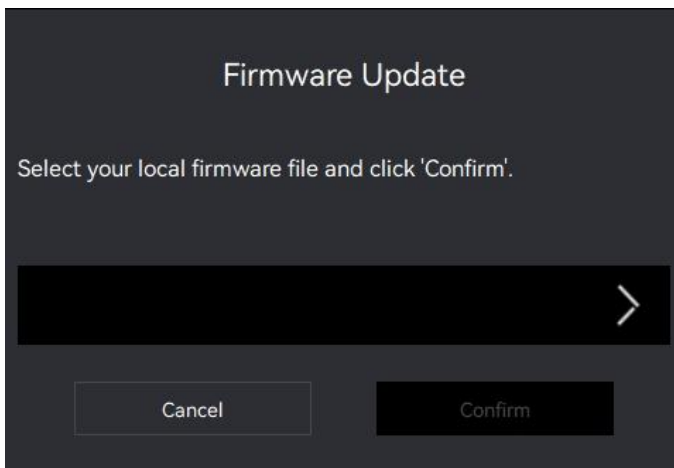
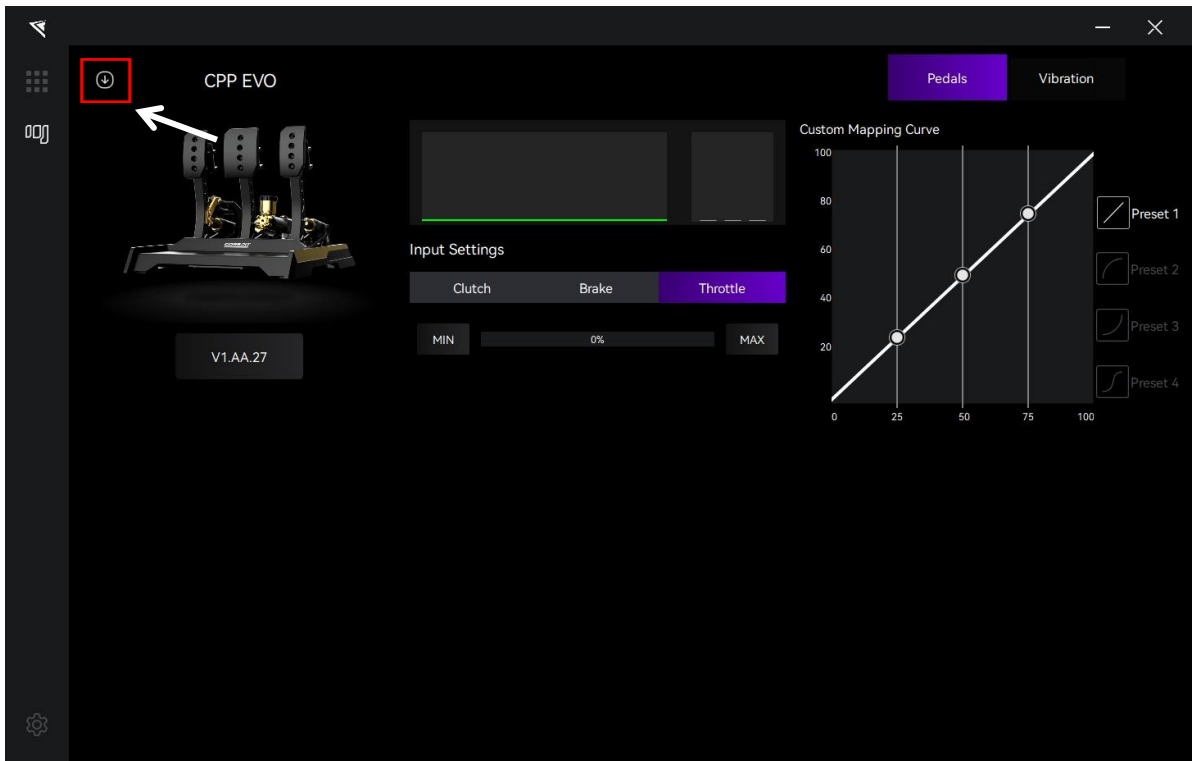

Click the ">" button on the right side of the pop-up window to select the firmware you have downloaded for the corresponding product; then click "Confirm" to update the firmware.

Note:

1) If the progress bar gets stuck, please unplug and replug the USB cable and try again.



## 2.7 One-Click Game Configuration

Enter the Homepage, and click on "One-click Game Configuration" to configure.

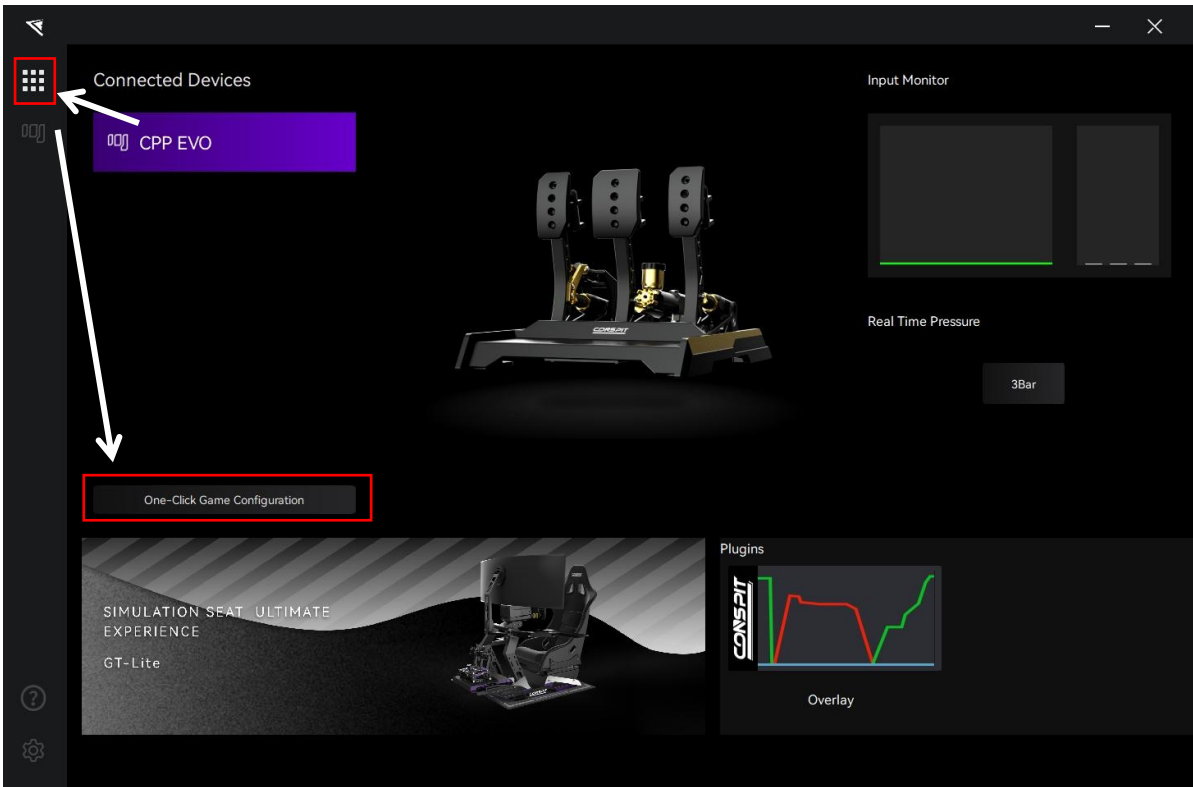

Or you can click on the "Settings" icon in the bottom left corner to enter the driver settings interface, and click on "One-click Game Configuration" to configure.

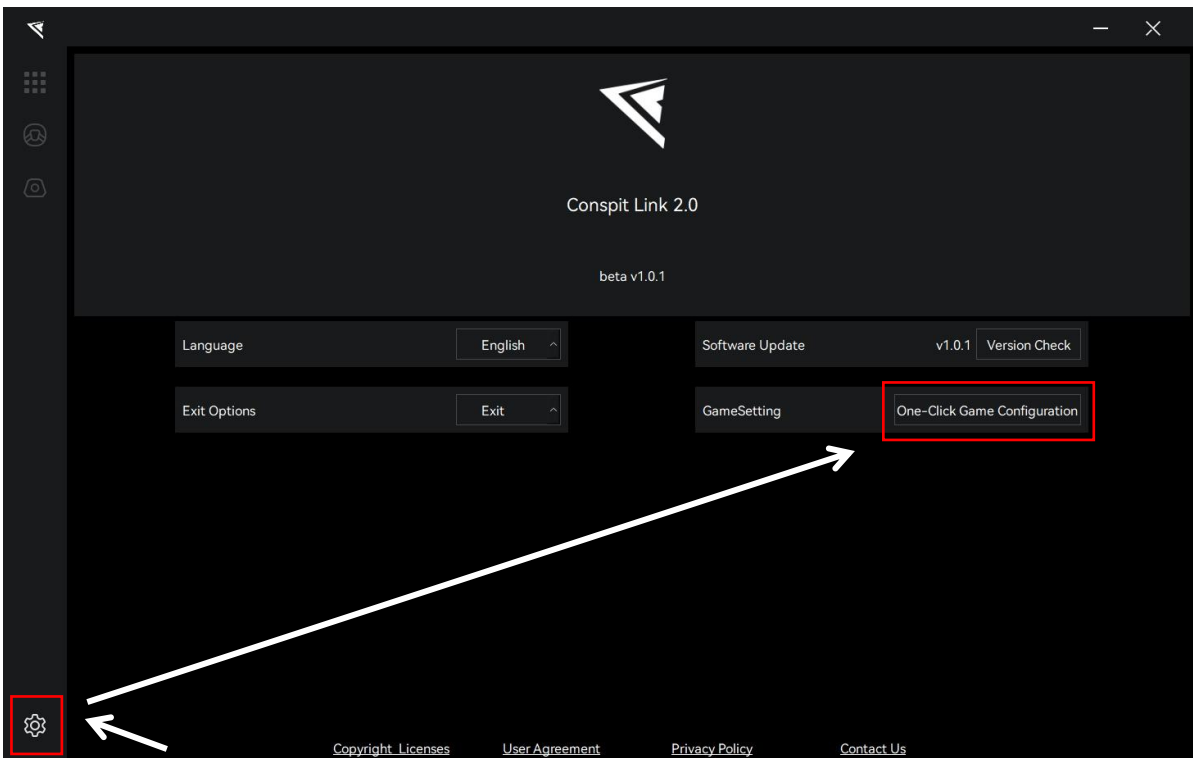



### 3. Game Compatibility List

Games	ABS	TC	Wheel Slip	Wheel Lock
Assetto Corsa	✓	✓	✓	✓
Assetto Corsa Competizione	✓	✓	✓	✓
iRacing	✓	x	✓	x
F1 Series	x	x	✓	✓
Automobilista 2	✓	✓	✓	✓
RaceRoom	✓	✓	✓	✓
Forza Horizon 5	x	x	✓	✓
rFactor 2	x	✓	✓	✓
Le Mans Ultimate	x	✓	✓	✓
Dirt Rally 2.0	x	x	✓	x
EA SPORTS™ WRC	x	x	✓	✓

**F1 Series Special Configuration:**

Enter the game, modify the settings, enable UDP, set the port to 20777.

Do not enable broadcast mode.

**Forza Horizon 5 Special Configuration:**

Enter the game, modify the settings, enable UDP, and set the port to 20777.

**rFactor 2 Special Configuration:**

One-click configuration is required within Conspit Link 2.0,

Enable telemetry plugin in the game settings.

**Le Mans Ultimate & Dirt Rally 2.0 Special Configuration:**

One-click configuration is required within Conspit Link 2.0



## 4. Troubleshooting Guide

### **I. Why does the pedal feel stiff and sluggish?**

Repeatedly step on it a few times. When a new pedal or a pedal that has not been used for a long time is repeatedly stepped on, the internal grease can re-adhere to the cylinder wall.

### **II. Why does the brake pedal make abnormal noises?**

Unscrew the preload knob and rubber cylinder cover, take out the rubber, apply the grease from the accessory pack onto the rubber, reinstall the rubber, and finally screw back the preload knob and rubber cylinder cover.

### **III. Why does the brake pedal have a slight play?**

Tighten the preload knob (if there are both front and rear, tighten them both). To facilitate changing the pin position, the brake pedal will have a natural play (2-3mm) when the preload knob is in a relaxed state.

### **IV. If you encounter any other problems, please consult CONSPIT official customer service.**



## 5. Revision History

Date	Version	Release Notes
2025.03.14	V1.1	Launch Control Settings added.
2024.09.23	V1.0	First release

## 6. Disclaimer and Copyright Notice

The information in this document, including the URL addresses provided for reference, is subject to change without notice.

This document may refer to third-party information, all of which is provided "as is" without any warranty of accuracy or authenticity from Conspit.

Conspit makes no warranties of any kind regarding the content of this document, including its merchantability, fitness for a particular purpose, or any other warranties mentioned in Conspit's proposals, specifications, or samples elsewhere.

Conspit does not guarantee that this document does not infringe upon third-party rights and shall not be held liable for any infringement of intellectual property rights arising from the use of the information contained in this document. This document does not grant any intellectual property licenses, either express or implied, by estoppel or otherwise.

All trademark names, trademarks, and registered trademarks mentioned in the document are the property of their respective owners and are hereby acknowledged.

© 2024 Ensu (Shanghai) Electronics Technology Co., Ltd. All rights reserved.